

PRODUCTS BROCHURE

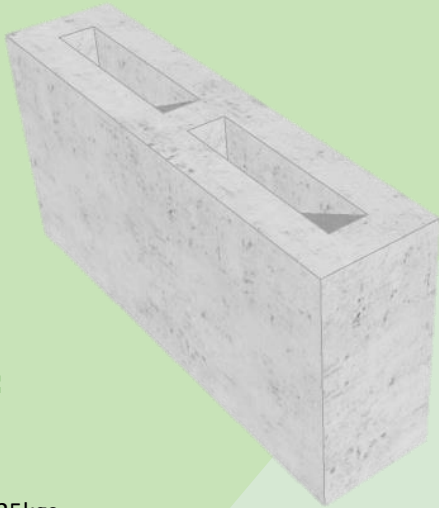

**EASTERN CAPE SUPPLIERS OF
TOP QUALITY
PRECAST CONCRETE PRODUCTS.**

M4 BLOCK



BLOCK SIZE:

Length: 390mm
Width: 90mm
Height: 190mm
Weight per Unit: 13,25kgs
Pallet Quantity: 96

M6 BLOCK

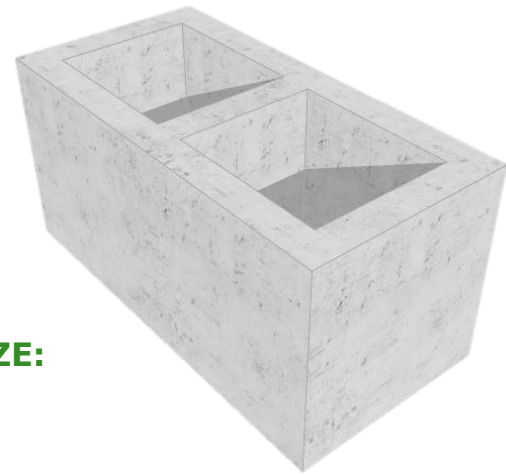

BLOCK SIZE:

Length: 390mm
Width: 190mm
Height: 140mm
Weight per Unit: 13,8kgs
Pallet Quantity: 60

M6 ROCKFACE

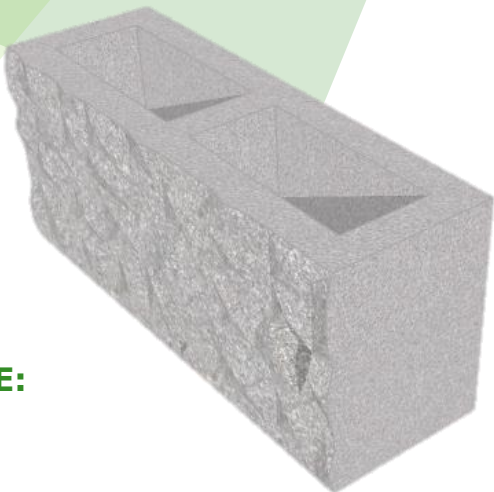

BLOCK SIZE:

Length: 390mm
Width: 190mm
Height: 140mm
Weight per Unit: 13,8kgs
Pallet Quantity: 60

PILASTER BLOCKS



BLOCK SIZE:

Length: 390mm
Width: 390mm
Height: 190mm
Multiple Variations
Weight per Unit: 24kgs
Pallet Quantity: 42

CEMENT PLASTER BRICK



BLOCK SIZE:

Length: 220mm
Width: 110mm
Height: 80mm
Weight per Unit: 3kgs
Pallet Quantity: 500

CEMENT SEMI FACE BRICK

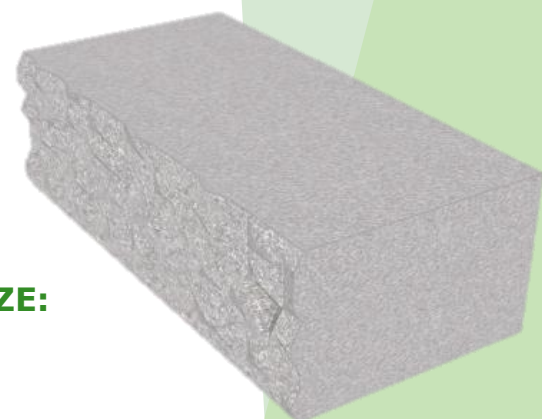

BLOCK SIZE:

Length: 220mm
Width: 110mm
Height: 80mm
Weight per Unit: 3,5kgs
Pallet Quantity: 500

Please note that all our colour ranges that are not GREY (stock standard) are made to order. Colour ranges are available for Cement Semi Face Brick.

NATURAL GREY

CHARCOAL

HONEY

TUSCANY

TERRACOTTA

VISIT OUR WEBSITE AND FOLLOW US ON FACEBOOK

400mm x 400mm x 50mm

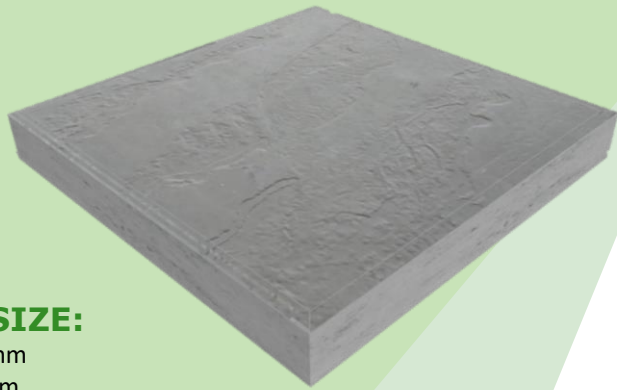

PAVER SIZE:

Length: 400mm
Width: 400mm
Height: 50mm
Per m²: 6,25
Weight per Unit: 19kgs

200mm x 200mm x 50mm



PAVER SIZE:

Length: 200mm
Width: 200mm
Height: 50mm
Per m²: 25
Weight per Unit: 5kgs
Pallet Quantity: 250

200mm x 100mm x 50mm



PAVER SIZE:

Length: 200mm
Width: 100mm
Height: 50mm
Per m²: 50
Weight per Unit: 2,75kgs
Pallet Quantity: 500

100mm x 100mm x 50mm



PAVER SIZE:

Length: 100mm
Width: 100mm
Height: 50mm
Per m²: 100
Weight per Unit: 1,12kgs
Pallet Quantity: 1000

BULL-NOSE



PAVER SIZE:

Length: 200mm
Width: 150mm
Height: 50mm
Per running m²: 5
Weight per Unit: 4,75kgs
Pallet Quantity: 250

BOND PAVERS



BLOCK SIZE:

Length: 200mm
Width: 100mm
Height: 50mm
Weight Per Unit: 2kgs
Pallet Quantity: 500
*80mm special order

Please note that all our colour ranges that are not GREY (stock standard) are made to order. Colour ranges are available for M6 Rockface and Pavers.

WHEAT

TAN

GREY

CHARCOAL

RED

INTERLOCKING PAVERS

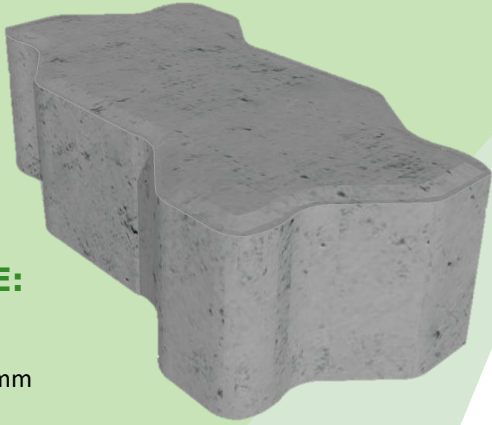

BLOCK SIZE:

Length: 200mm
Width: 100mm
Height: 60mm | 80mm
Weight Per Unit:
60mm | 80mm
2,6kgs | 3,2kgs
Pallet Quantity: 500

*80mm special order

V10 CORNER BLOCK

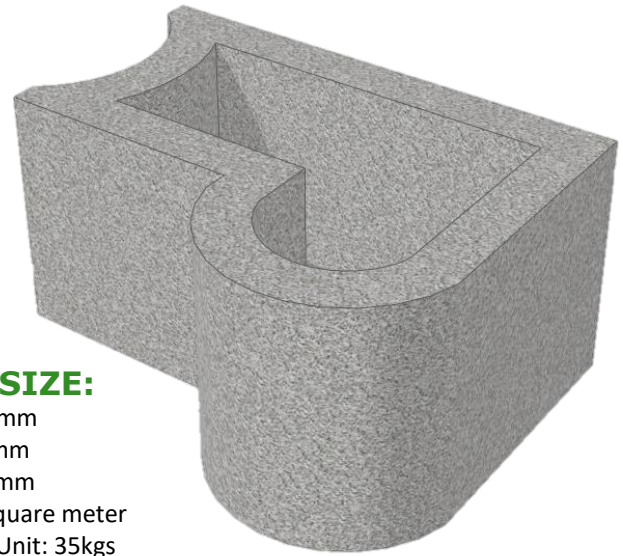

BLOCK SIZE:

Length: 500mm
Width: 300mm
Height: 250mm
570kg per square meter
Weight per Unit: 35kgs
Pallet Quantity: 30

V10 RETAINER BLOCK

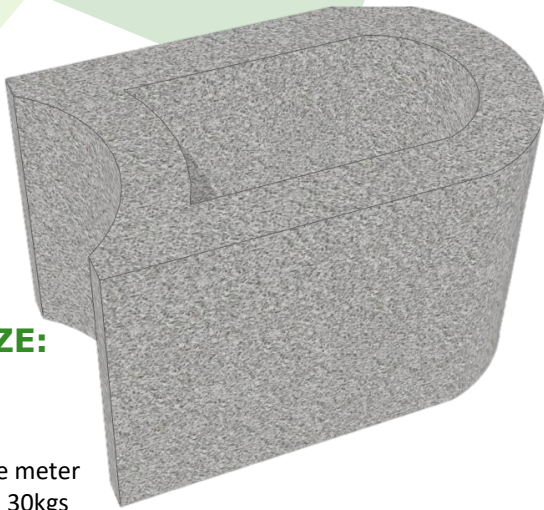

BLOCK SIZE:

Length: 400mm
Width: 250mm
Height: 250mm
390kg per square meter
Weight per Unit: 30kgs
Pallet Quantity: 48

Please note that all our colour ranges that are not GREY (stock standard) are made to order. Colour ranges are available for interlocking pavers.

NATURAL GREY

CHARCOAL

HONEY

TUSCANY

TERRACOTTA

SUPERIOR PRODUCTS

Representing manufacturers of top-class concrete products. TFSD is the new trading arm of Mondrich Trading which is a long established manufacturer of pre-cast concrete products.

We supply innovative concrete products that provide for cost effective, everlasting, fast track construction systems, by and for the Eastern Cape built environment.

We commit to always being on time, backed up by our on-site technical service and years of practical experience.